











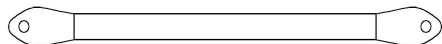
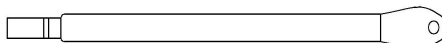
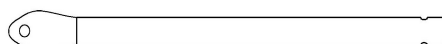
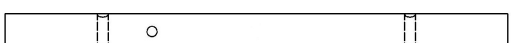
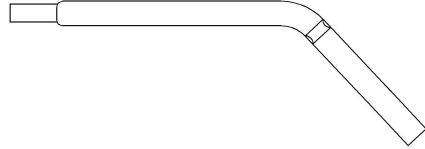
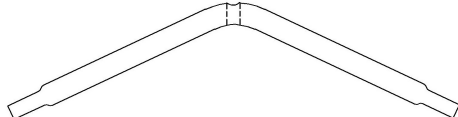

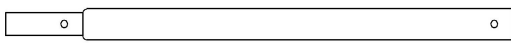

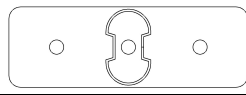



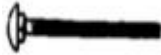

# 6X12M TENT

## Part list

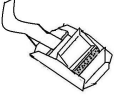
			<b>quantity</b>
<b>1</b>	Oval corner leg		<b>18</b>
<b>2</b>	Oval leg		<b>18</b>
<b>3</b>	Diagonal 25mm		<b>16</b>
<b>4</b>	Top strength pipe male		<b>9</b>
<b>5</b>	Top strength pipe female		<b>9</b>
<b>6</b>	Top oval corner extension pipe		<b>18</b>
<b>7</b>	Oval corner arch		<b>18</b>
<b>8</b>	Oval middle arch		<b>9</b>
<b>9</b>	Horizontal connection pipe female		<b>99</b>
<b>10</b>	Horizontal connection pipe male		<b>11</b>
<b>11</b>	Fasten bar Round pipe 25mm 1400mm		<b>16</b>
<b>12</b>	Foot		<b>22</b>
	10x305mm		<b>16</b>
	Floor Bracket		<b>8</b>
	Spiral peg		<b>4</b>

	1.75" screw		9
	2.5" screw		18
	4" Screw		99
	4.5" Screw		16
	Wing nut		134
	Spancer		2
	Bolt with nut 8x50mm		18
	Zinc strap		32
	Tie-down kit		4
	6x180mm		56
	8x300mm		36
	Bungee		124
	Supper stake		18
	Roof		1
	Door		2

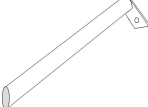
--	--	--	--

## Frame assembly instruction

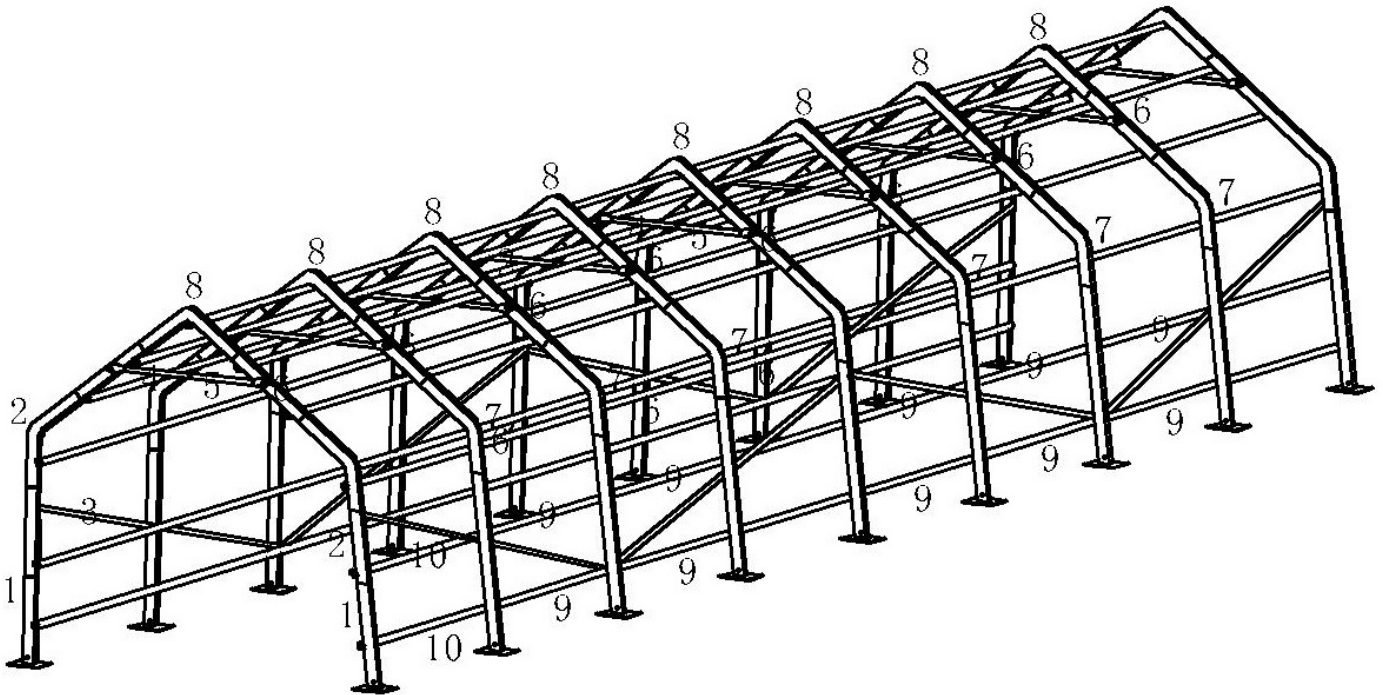

### Attention

Please use gloves when assembling, the metal frame portion of this unit. The metal components of this products have been treated, with a rust preventive coating that may feel oily to the touch. This coating is not dangerous, but may dirty your hands during assembly. We recommend that you wipe metal parts clean with a mixture of warm water and dish detergent prior to assembly. Should your hands become dirty, simply wash with soap and water.



Step1 .To bulid first section .

A. Place all center arch(no.8) on ground like below image .

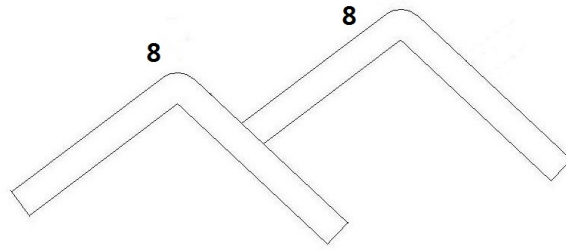

B. Contact this two arches together by cross bar no.10 and no.9 like below ,no 9 is for add-on section, with 4 inches screws

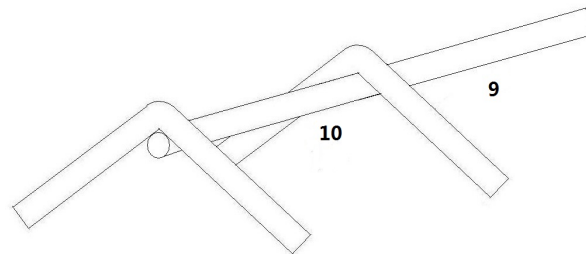

C .Attach the extension bar to the center arch and fix the ceiling rail to extension bar(No.6 and 11) , Use screw 1.75" to connect No.4 and 5. When tighten No.8 with No.6 or No.11, use 2.5" screws. Always keep the wind nut on inside

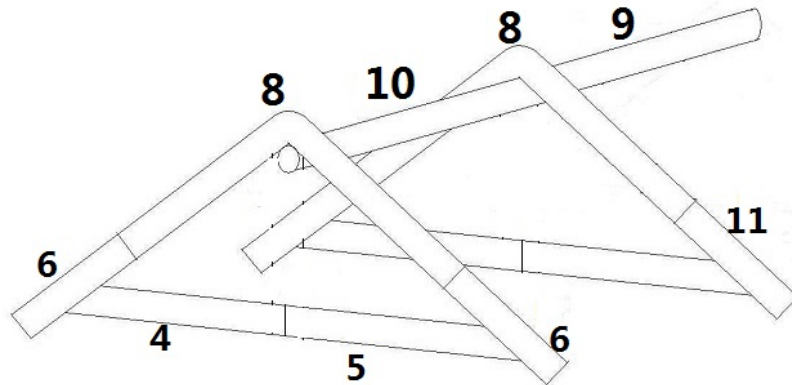

D. Insert corner arch No.7 to extension bar No. 6 and No.11 .Do to keep at least one person to keep the structure in upright direction . Use Screw 2.5" to connect No.6 to 7.

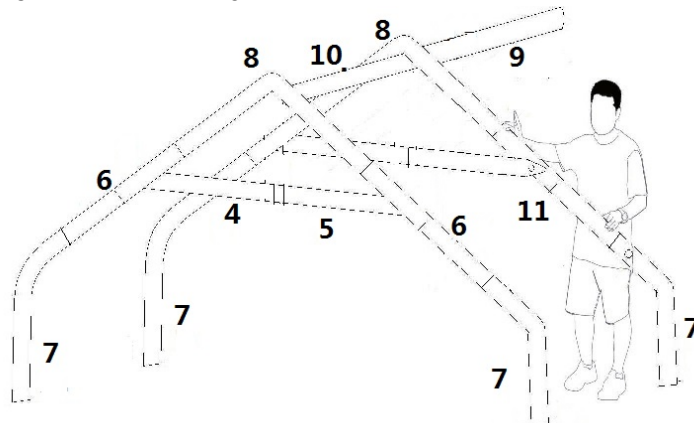

E. Connect the corner arch by cross bar pipe no. 10 and no. 9 with screw (screw 4"). Still , no. 9 is for add-on sections .

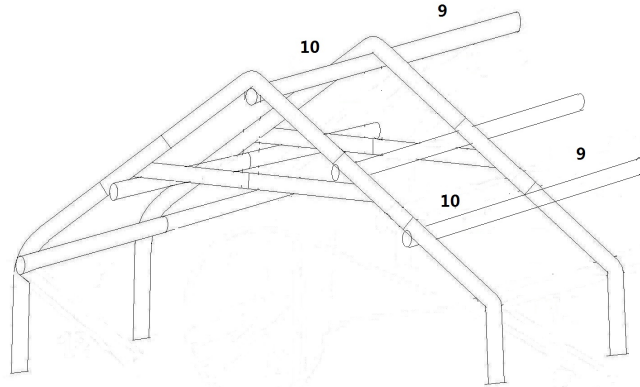

F. Insert leg No.1 and No.2 in to the corner arch .And connect them by cross bar no.10 and no.9 with screws (4" screw ). No. 9 is for add-on sections . Also at this point, use diagonal 3 to make the frame stable. Any position to put on diagonal 3, use screw 4.5".

Pls note that there is 9 mian frames. Try the above step again until you finish all the frame like below.

Two things need to be careful.

No. 12 is the foot, pls add the foot to the leg before you inster to the corner arch, otherwise it will be heavy to lift the frame to put the foot on after.

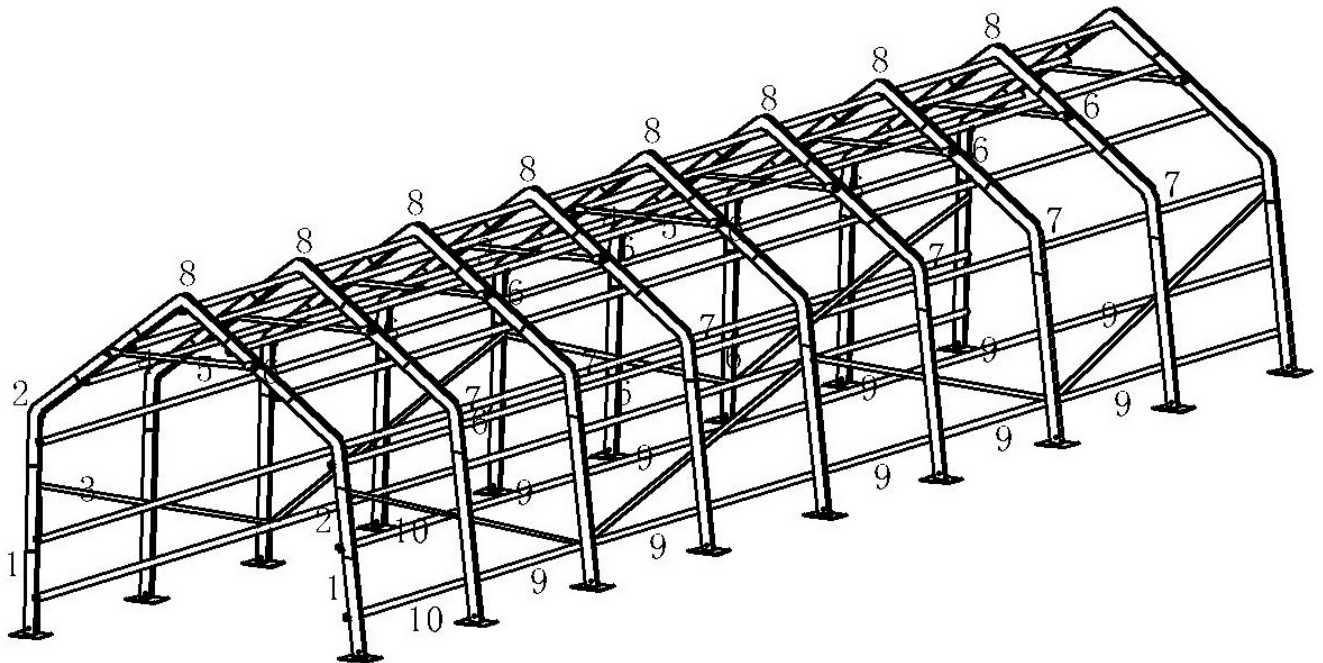

To Spread the cover over the frame. Please pay attention to all sharp edges and potential harm to the cover. Insert pipe No.11 into the bucket at the bottom of the roof .Fasten it with strap,like below picture. Fasten the roof to the structure and by fix it ground with tie down kit .

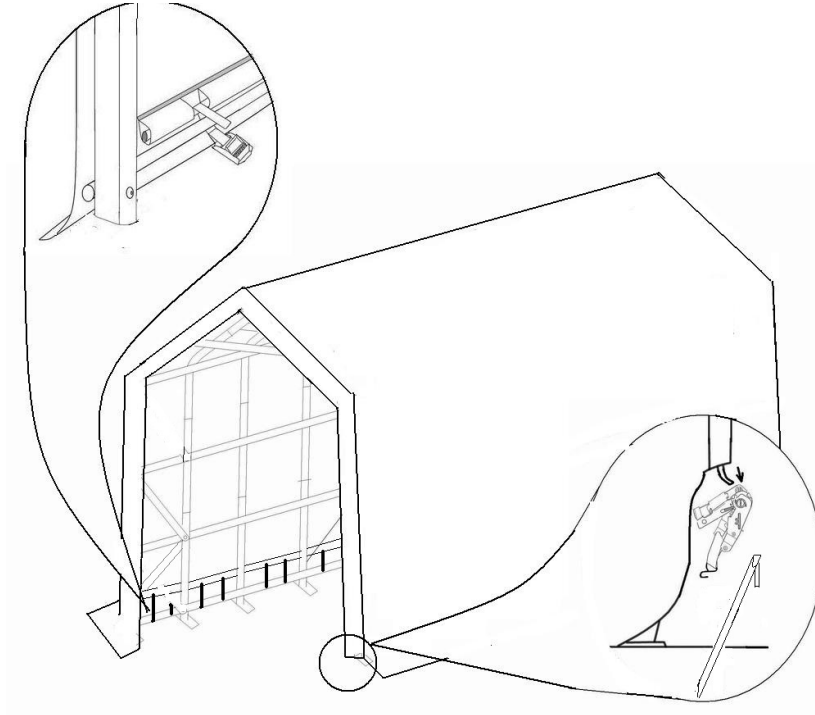

Hang the endwall with bungee ball the the frame door .,Use 6x180mm to fix the skirt to ground .

